

Adding Sounds

You can have sounds play for pretty much every situation. When an input turns on or off, when the puzzle is solved, when time runs out, etc. When you first insert the SD card into the controller the mode light will turn red as it creates the folder structure. When that's done you can eject the card and put it in a computer. Inside the EK folder you'll find a large list of sound folders. Inside each folder is a README.TXT file explaining when sounds in that folder will play and how the files should be named.

Recording

Recording the Puzzle Solution

If you selected the Input Sequence or Morse Code puzzle mode you need to teach the EscapeKeeper the solution to the puzzle. Tap REC, then push the buttons or activate the sensors as the players would if they solved the puzzle correctly, then tap REC again to save. If you selected Input State Match you just need to set your inputs to the winning state and tap REC once to save that state as the solution. Tap button 3 after recording to start the puzzle. Other modes not mentioned do not require a solution to be recorded.

Recording Output Animation

By default, outputs 2 and 3 indicate the pass / fail status of the puzzle. If you'd like you can customize what the outputs do in most states of the puzzle. You must first select what scene you want to record, see below for the list. Once selected, tap REC, if you have audio for this state it will start playing. As you listen to the audio you can use the 2 / 3 buttons to control the outputs. Tap REC when you're done. To preview what you just recorded tap button 3.

NOTE: To exit record / preview mode and start the puzzle again you must hold button 3 for a few seconds.

A few notes:

- To erase the current state's animation tap record twice quickly.
- If ANY of the states have custom animation in them outputs 2 & 3 will no longer indicate pass / fail status.
- If you'd like an output to remain on after the animation is played make sure you are still holding the output button when you stop recording. This is useful if you want an output to stay on after the animation has finished playing.

Selecting what to Record

Hold the REC button for a few seconds until the light above it turns blue. While still holding the button, turn the Volume knob to select what you'd like to record, then let go.

- | | | | | | | | | |
|---|---|---|---|---|---|---|---|---|
| 1 | 2 | 3 | 4 | 5 | 6 | 7 | 8 | Puzzle Solution - The default at startup. Record the puzzle solution on the inputs. |
| 1 | 2 | 3 | 4 | 5 | 6 | 7 | 8 | Master Code - Master code for Input Sequence and Custom Keypad. (See full manual) |
| 1 | 2 | 3 | 4 | 5 | 6 | 7 | 8 | Game Start - Output 2 & 3 animation that is played when the game is started. |
| 1 | 2 | 3 | 4 | 5 | 6 | 7 | 8 | Game Loop - Output 2 & 3 animation that is looped while the game is active. |
| 1 | 2 | 3 | 4 | 5 | 6 | 7 | 8 | Miss - Output 2 & 3 animation that is played when an incorrect attempt is made. |
| 1 | 2 | 3 | 4 | 5 | 6 | 7 | 8 | Success - Output 2 & 3 animation that is played when the puzzle is solved. |
| 1 | 2 | 3 | 4 | 5 | 6 | 7 | 8 | Failed - Output 2 & 3 animation that is played when the game times out or tries run out. |

Basic Operation

When the EscapeKeeper boots up it will sit idle, unless Auto-Reset is enabled in which case it will start the game immediately. To start the game manually tap button 3 or pulse the reset input.

After a game completes, the pass or fail status will be indicated on the mode LED as green or red. At that point you can tap button 3 or use the reset input to restart the game.

You can wire the reset input to a switch or button. When the reset input is ON the game is held in reset and any maglocked door is kept locked. If the EscapeKeeper sees one of the inputs isn't ready for the game to start it will beep, NOT lock the door, blink the mode LED red and indicate which input is the problem. Once that issue is resolved you can attempt the reset again. Turning the reset input OFF will allow the game to start.

Stopping the Game

During the game, the game can be stopped and the door unlocked by tapping button 3 once, or the reset input twice.



Quick-Start Guide EscapeKeeper



NEED HELP?

There are tutorial videos and a complete manual available at help.frightideas.com/504



Input and Reset Wiring

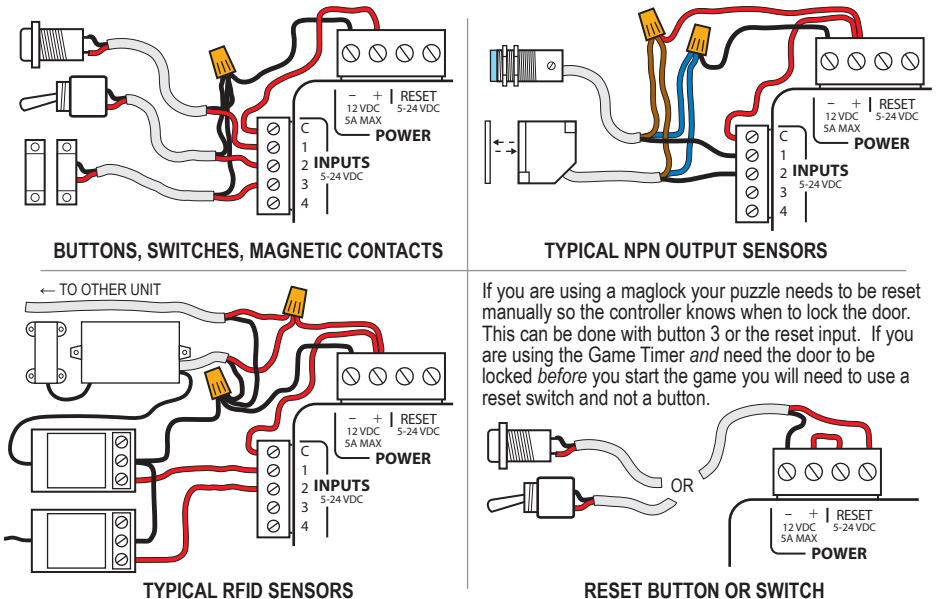

Linking EscapeKeepers

EscapeKeepers can be linked together as shown below to force puzzles to be solved in order. Additional puzzles remain in reset until the previous puzzle is solved, after which it comes to life and plays an optional startup sound.

NOTE: The *Output 1 Mode* of the EscapeKeepers holding additional units in reset must be set to 7.

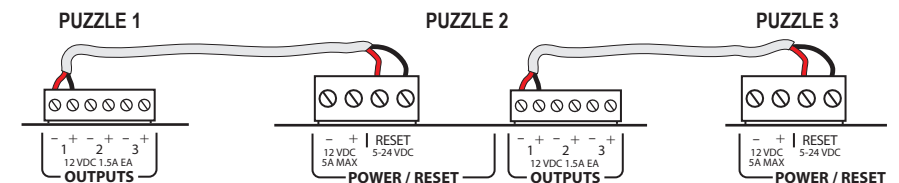

Output Wiring

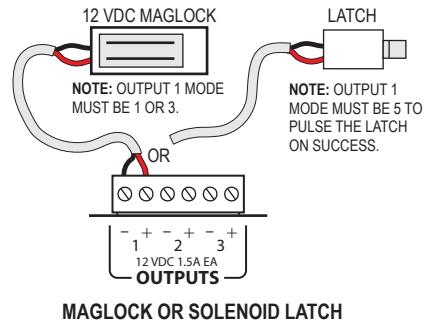
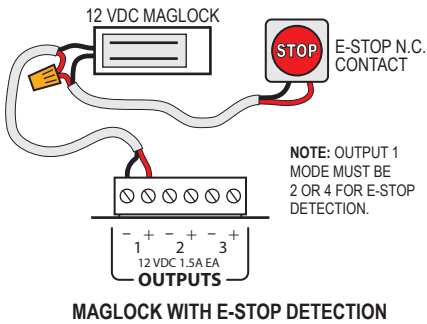

OUTPUTS CAN BE USED TO CONTROL ANY 12 VDC DEVICES UNDER 1.5 AMPS (18 WATTS).

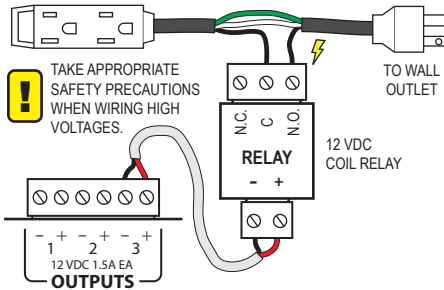
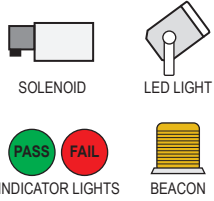
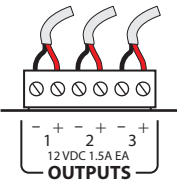



Initial Setup and Factory Reset



Power up holding button 3 to enter setup mode. You can let go when the MODE light starts flashing blue. The current setting will be shown on the yellow LEDs. For each step below, use the volume knob to adjust the setting, then tap 3 to advance to the next step. You must advance through all the settings for any changes to be saved.

NOTE: If you get stuck you can visit help.frightideas.com/504 to see a video of the setup process.



Initial Setup Steps

 x1	<p>Puzzle Mode The puzzle mode defines how the EscapeKeeper operates.</p> <p>1 2 3 4 5 6 7 8 Input Sequence - Players must activate the inputs in a specific sequence.</p> <p>1 2 3 4 5 6 7 8 Morse Code - Players must match your sequence of short and long presses.</p> <p>1 2 3 4 5 6 7 8 Input State Match - Players must match the inputs to a recorded input state.</p> <p>1 2 3 4 5 6 7 8 Number of Inputs - Players must activate a certain number of inputs.</p> <p>1 2 3 4 5 6 7 8 Mission Impossible - Players must activate win input without tripping others.</p>
 x2	<p>Number of Puzzle Inputs Number of buttons, switches, or sensors used for the puzzle. Remaining inputs can play sounds or hints.</p> <p>1 2 3 4 5 6 7 8 Puzzle Inputs - Select the number of inputs used in the puzzle. For Mission Impossible mode see the full manual online for more information.</p>
 x3	<p>Output 1 Mode Output 1 is dedicated to lock control or success indication. Choose one of the modes below.</p> <p>1 2 3 4 5 6 7 8 Maglock, NO E-Stop, Unlock - Maglock, unlocks on failure / timeout.</p> <p>1 2 3 4 5 6 7 8 Maglock, E-Stop, Unlock - E-Stop detection on, unlock on failure / timeout.</p> <p>1 2 3 4 5 6 7 8 Maglock, NO E-Stop - Maglock</p> <p>1 2 3 4 5 6 7 8 Maglock, E-Stop - Maglock, E-Stop detection.</p> <p>1 2 3 4 5 6 7 8 Pulse On - Output will turn on for 1 second if the puzzle is solved.</p> <p>1 2 3 4 5 6 7 8 Turn On - Output will turn on and stay on if the puzzle is solved.</p> <p>1 2 3 4 5 6 7 8 Link Mode - Use to link this unit to one that will turn on after this one is solved.</p>

Initial Setup Steps (continued)

 x4	<p>Auto-Reset Timer This timer starts when the puzzle is solved or fails due to timeout or too many attempts. When it expires it restarts the puzzle allowing it to be solved again.</p> <table border="0"> <tr> <td>1 2 3 4 5 6 7 8 Off</td> <td>1 2 3 4 5 6 7 8 30 sec</td> <td>1 2 3 4 5 6 7 8 10 min</td> </tr> <tr> <td>1 2 3 4 5 6 7 8 After Sound</td> <td>1 2 3 4 5 6 7 8 1 min</td> <td>1 2 3 4 5 6 7 8 15 min</td> </tr> <tr> <td>1 2 3 4 5 6 7 8 5 sec</td> <td>1 2 3 4 5 6 7 8 2 min</td> <td>1 2 3 4 5 6 7 8 30 min</td> </tr> <tr> <td>1 2 3 4 5 6 7 8 15 sec</td> <td>1 2 3 4 5 6 7 8 5 min</td> <td>1 2 3 4 5 6 7 8 60 min</td> </tr> </table>	1 2 3 4 5 6 7 8 Off	1 2 3 4 5 6 7 8 30 sec	1 2 3 4 5 6 7 8 10 min	1 2 3 4 5 6 7 8 After Sound	1 2 3 4 5 6 7 8 1 min	1 2 3 4 5 6 7 8 15 min	1 2 3 4 5 6 7 8 5 sec	1 2 3 4 5 6 7 8 2 min	1 2 3 4 5 6 7 8 30 min	1 2 3 4 5 6 7 8 15 sec	1 2 3 4 5 6 7 8 5 min	1 2 3 4 5 6 7 8 60 min			
1 2 3 4 5 6 7 8 Off	1 2 3 4 5 6 7 8 30 sec	1 2 3 4 5 6 7 8 10 min														
1 2 3 4 5 6 7 8 After Sound	1 2 3 4 5 6 7 8 1 min	1 2 3 4 5 6 7 8 15 min														
1 2 3 4 5 6 7 8 5 sec	1 2 3 4 5 6 7 8 2 min	1 2 3 4 5 6 7 8 30 min														
1 2 3 4 5 6 7 8 15 sec	1 2 3 4 5 6 7 8 5 min	1 2 3 4 5 6 7 8 60 min														
 x5	<p>Game Timer Used to automatically fail the game if the players take too long.</p> <table border="0"> <tr> <td>1 2 3 4 5 6 7 8 Off</td> <td>1 2 3 4 5 6 7 8 4 min</td> <td>1 2 3 4 5 6 7 8 20 min</td> </tr> <tr> <td>1 2 3 4 5 6 7 8 1 min</td> <td>1 2 3 4 5 6 7 8 5 min</td> <td>1 2 3 4 5 6 7 8 30 min</td> </tr> <tr> <td>1 2 3 4 5 6 7 8 2 min</td> <td>1 2 3 4 5 6 7 8 10 min</td> <td>1 2 3 4 5 6 7 8 40 min</td> </tr> <tr> <td>1 2 3 4 5 6 7 8 3 min</td> <td>1 2 3 4 5 6 7 8 15 min</td> <td>1 2 3 4 5 6 7 8 50 min</td> </tr> <tr> <td></td> <td></td> <td>1 2 3 4 5 6 7 8 60 min</td> </tr> </table>	1 2 3 4 5 6 7 8 Off	1 2 3 4 5 6 7 8 4 min	1 2 3 4 5 6 7 8 20 min	1 2 3 4 5 6 7 8 1 min	1 2 3 4 5 6 7 8 5 min	1 2 3 4 5 6 7 8 30 min	1 2 3 4 5 6 7 8 2 min	1 2 3 4 5 6 7 8 10 min	1 2 3 4 5 6 7 8 40 min	1 2 3 4 5 6 7 8 3 min	1 2 3 4 5 6 7 8 15 min	1 2 3 4 5 6 7 8 50 min			1 2 3 4 5 6 7 8 60 min
1 2 3 4 5 6 7 8 Off	1 2 3 4 5 6 7 8 4 min	1 2 3 4 5 6 7 8 20 min														
1 2 3 4 5 6 7 8 1 min	1 2 3 4 5 6 7 8 5 min	1 2 3 4 5 6 7 8 30 min														
1 2 3 4 5 6 7 8 2 min	1 2 3 4 5 6 7 8 10 min	1 2 3 4 5 6 7 8 40 min														
1 2 3 4 5 6 7 8 3 min	1 2 3 4 5 6 7 8 15 min	1 2 3 4 5 6 7 8 50 min														
		1 2 3 4 5 6 7 8 60 min														
	<p>! Puzzle Mode Options If the MODE light starts blinking green, select ONLY 1 of the 2 tables below based on the Puzzle Mode you selected in the first step. Once the MODE light turns off your setup is complete.</p>															

ONLY FOR Input Sequence & Morse Code Puzzle Modes

 x1	<p>Miss on Input Timeout Use this to limit the maximum number of seconds between inputs in the sequence. This option will fail the current attempt and play any Miss sound if they take too long to activate the next input, button, etc.</p> <table border="0"> <tr> <td>1 2 3 4 5 6 7 8 No Timeout - There's no limit to how long they can take.</td> </tr> <tr> <td>1 2 3 4 5 6 7 8 Timeout - Number of seconds until the current attempt times out. (6 shown)</td> </tr> </table>	1 2 3 4 5 6 7 8 No Timeout - There's no limit to how long they can take.	1 2 3 4 5 6 7 8 Timeout - Number of seconds until the current attempt times out. (6 shown)
1 2 3 4 5 6 7 8 No Timeout - There's no limit to how long they can take.			
1 2 3 4 5 6 7 8 Timeout - Number of seconds until the current attempt times out. (6 shown)			
 x2	<p>Options Move the flashing cursor using the knob. Toggle options off and on by tapping REC. ON/OFF</p> <p>Once your options are set, tap button 3 to complete the setup process.</p> <p>1 2 3 4 5 6 7 8 Miss at Code Length - The attempt will miss when the number of input entries (usually button presses) in their attempt matches the amount in your solution. This will tip them off to the length of the code if you have a Miss sound.</p> <p>1 2 3 4 5 6 7 8 Miss on Bad Input - The current attempt will be declared a miss as soon as they trigger the wrong input. If you have a Miss sound, this would allow the players to slowly figure out the code by trial and error. (ignored for Morse Code)</p>		

ONLY FOR Input State Match Puzzle Mode

 x1	<p>Options Move the flashing cursor using the knob. Toggle options off and on by tapping REC. ON/OFF</p> <p>Once your options are set, tap button 3 to complete the setup process.</p> <p>1 2 3 4 5 6 7 8 Use Submit Button - Instead of having the puzzle succeed once they've matched the input state, require them to also press a button. This submission allows you to limit the number of tries they have, for example, to disarm a bomb, launch a missile, etc. Connect button to input 8, or 7 if puzzle bypass is enabled.</p>
--	--

Advanced Options

See the Advanced Options section in the full manual if you'd like write-protection, a puzzle bypass, a limit on the number of attempts, or an RFID chatter filter.

Factory Reset

Power up holding the black 2 & 3 buttons. Let go when the REC LED flashes red continuously. Sounds will NOT be erased.